



Induction Motor



Induction Motor

Index

Outline of Induction Motor	B-07
Induction Motor 6W (□ 60mm)	B-09
Induction Motor 6W (□ 70mm)	B-11
Induction Motor 10W (□ 70mm)	B-13
Induction Motor 15W (□ 70mm)	B-15
Induction Motor 15W (□ 80mm)	B-17
Induction Motor 25W (□ 80mm)	B-20
Induction Motor 40W (□ 90mm)	B-23
Induction Motor 60W (□ 90mm)	B-26
Induction Motor 90W (□ 90mm)	B-30
Induction Motor 120W (□ 90mm)	B-34
Induction Motor 150W (□ 90mm)	B-38
Induction Motor 180W (□ 90mm)	B-41
Induction Motor 200W (□ 90mm)	B-44
Induction Motor 250W (□ 104mm)	B-47
Induction Motor 300W (□ 104mm)	B-50
Induction Motor 400W (□ 104mm)	B-53

DKM AC/DC Geared Motor and Gearbox **B-06**

Änderungen und Irrtümer auch technischer Art vorbehalten!

B AC Motors

Outline of Induction Motor

☐ Suitable for Unidirectional Continuous Operation

- Induction motors are suitable for unidirectional continuous operation such as conveyor belt system.

☐ Single Phase Run

- For the running of a single phase motor, please use the capacitor complying with the capacity of the motor. For a single phase induction motor, it is not possible to reverse the direction within a short time during operation. So stop the motor first and change the direction next. (Figure 1)

☐ Three Phase Run

- Three phase induction motor has relatively high starting torque comparing single phase motor and has high reliability because it can be directly operated by a three phase power source. (Figure 2)

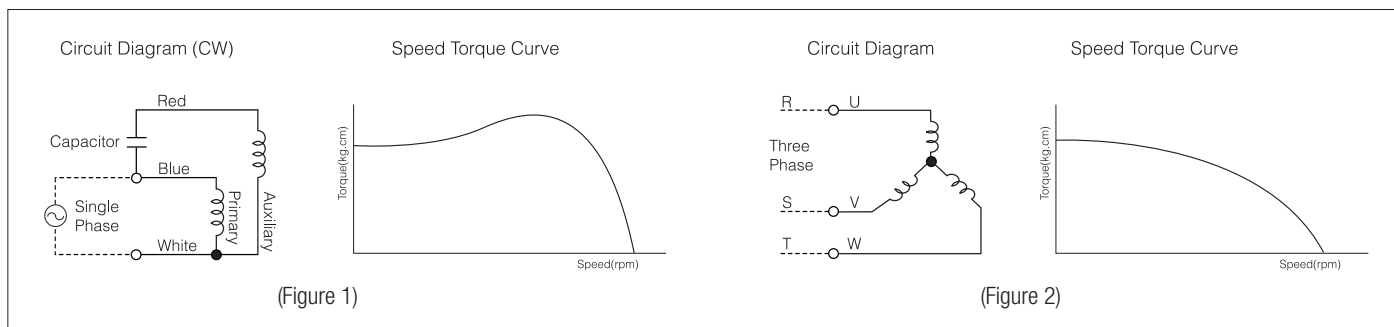

☐ The Relation between Speed and Torque

- In a condition of constant power voltage, the relation between speed and torque is like next figure. Under the condition of no-load, the number of rotation is roughly same as the number of synchronous rotation. But if the load increases, the number of rotation decreases and approaches to the speed (r/min) indicated by the point P where the torque T_p horizontally meets the load curve. When the load further increases and reaches the point M, the motor stops at the point R because the motor no longer generates further torque. Therefore, the leg R-M is referred to as an unstable zone and the leg O-M is a stable zone for operation.

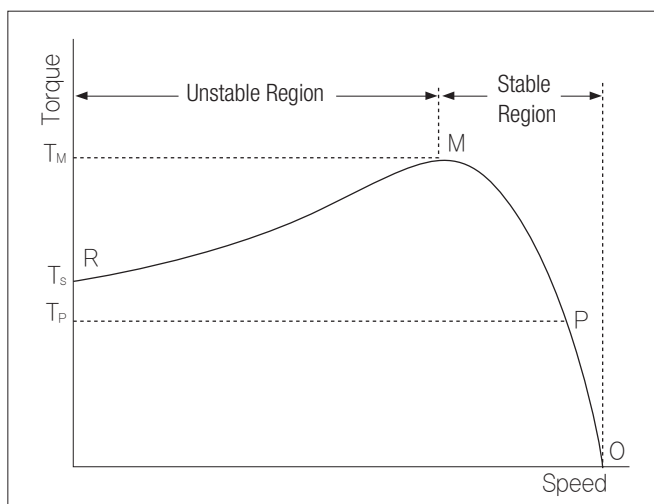

☐ Features of Voltage and Capacitor

- Generally the torque of induction motor changes proportionate to twice the voltage and it also changes according the capacity of the capacitor. If the capacity of the capacitor increases, the starting torque and rated torque will increase. But if the capacity increases by over 2 times, the rated torque decreases and starting torque do not increase. When the induction motor is short on torque, it is possible to increase the torque by increasing the voltage or the capacity of the capacitor to continue the operation. But please be informed that in this case the loss input of the motor increases and the temperature rises rapidly. However, if the motor must be run with insufficient torque, take measures to let the motor release heat as much as possible by installing separate fan as an example and operate the motor while keeping the temperature of the motor's housing below 90°C.

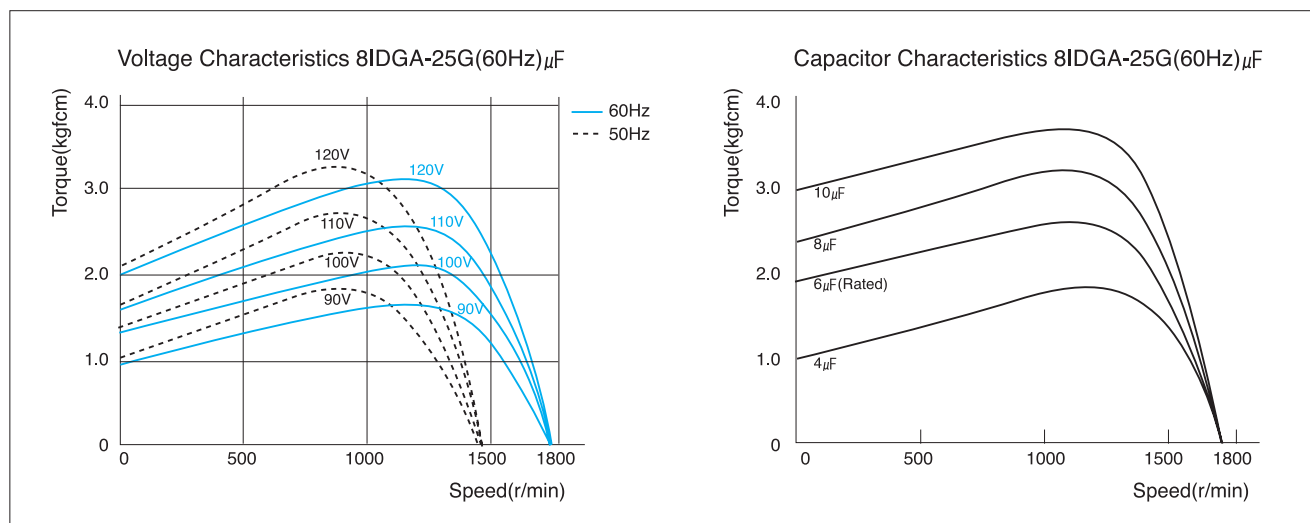

General Specifications

Item	Specification
Insulation Resistance	100MΩ or more when DC500V MEGA is applied between the windings and the frame after rated motor operation under normal ambient temperature and humidity.
Dielectric Strength	Sufficient to withstand 1.5KV at 50Hz and 60Hz applied between the windings and the frame for 1 minute after rated motor operation under normal ambient temperature and humidity.
Temperature Rise	Temperature rise of windings are 80°C or less measured by the resistance change method after rated motor operation with connecting a Gearbox or equivalent heat radiation plate.
Insulation Class	Class B [130°C]
Overheat Protection	Operating temperature (Built-in thermal protector type motor): Open 120°C±5°C, Close 90°C±5°C
Ambient Temperature	-10°C~+40°C (Three phase 220VAC: -10°C~+50°C)
Ambient Humidity	85% maximum

Connection Diagrams

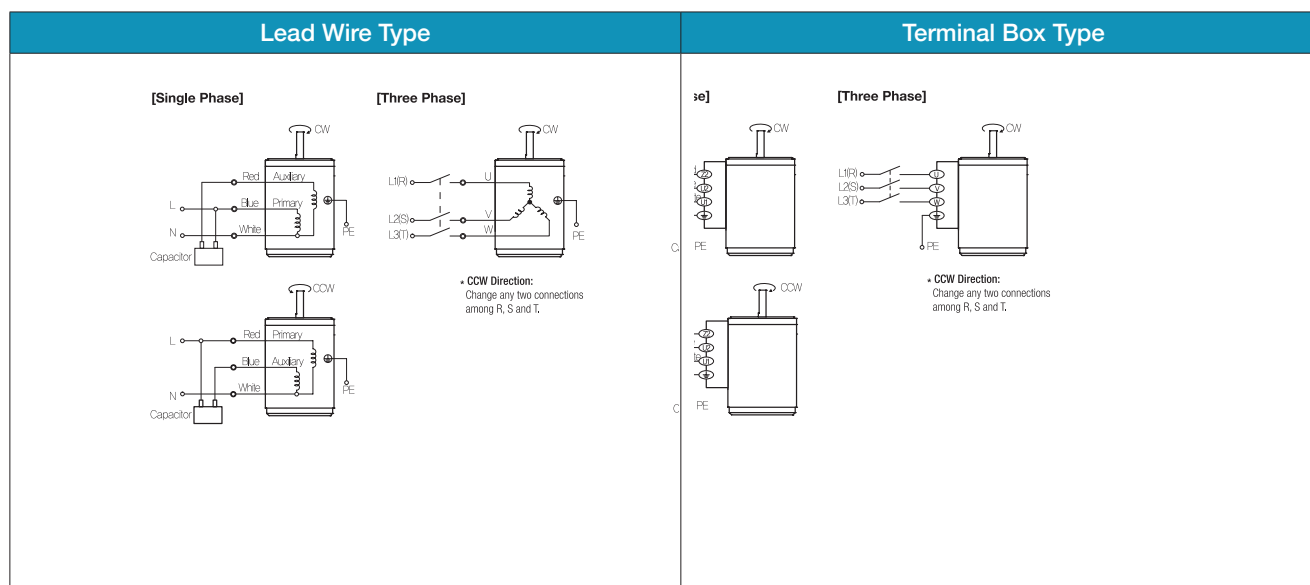

A Information

I Product Coding System

AC Motors

Motor

- I** : Induction Motor
- R** : Reversible Motor
- B** : Electromagnetic Brake Motor
- Cl** : Clutch & Brake Motor
- T** : Torque Motor
- S** : Speed Control Induction Motor
- SR** : Speed Control Reversible Motor
- SB** : Speed Control . Brake Motor
- CS** : Speed Control Clutch & Brake Motor

Phase & Voltage

- 1 : 1Ø AC 110V 60Hz
- 2 : 1Ø AC 220V 60Hz
- 3 : 3Ø AC 220~230V 50/60Hz
- 4 : 3Ø AC 380V~400V 50/60Hz
- 5 : 3Ø AC 415V~440V 50/60Hz
- 6 : 3Ø AC 220/380V 60Hz
- 7 : 3Ø AC 230/400V 50Hz
- 8 : 3Ø AC 440V 50/60Hz

Phase & Voltage

[Built-in Thermal Protector Type]

- A** : 1Ø AC 110V 60Hz
- D** : 1Ø AC 220V 60Hz
- E** : 1Ø AC 220~240V 50Hz
- G** : 3Ø AC 220V 50/60Hz
- K** : 3Ø AC 380V~400V 50/60Hz
- L** : 3Ø AC 415V~440V 50/60Hz

Fan Type

- F** : General Fan (Self Cooling)
- F2** : Powerful Fan (Separate Fan Motor)
Powerful fan makes powerful cooling performance rotating in high speed regardless of motor shaft speed.
- No Mark** : Without Fan

Connection Type

- T** : Terminal Box Type
- No Mark** : Lead Wire Type

Pole

- A** : 2 Pole
- No Mark** : 4 Pole

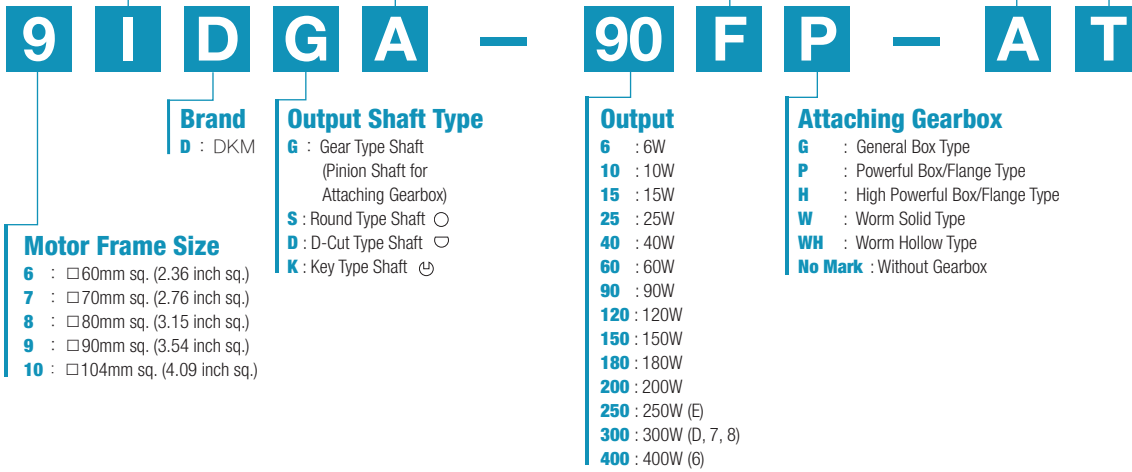

DC Motors

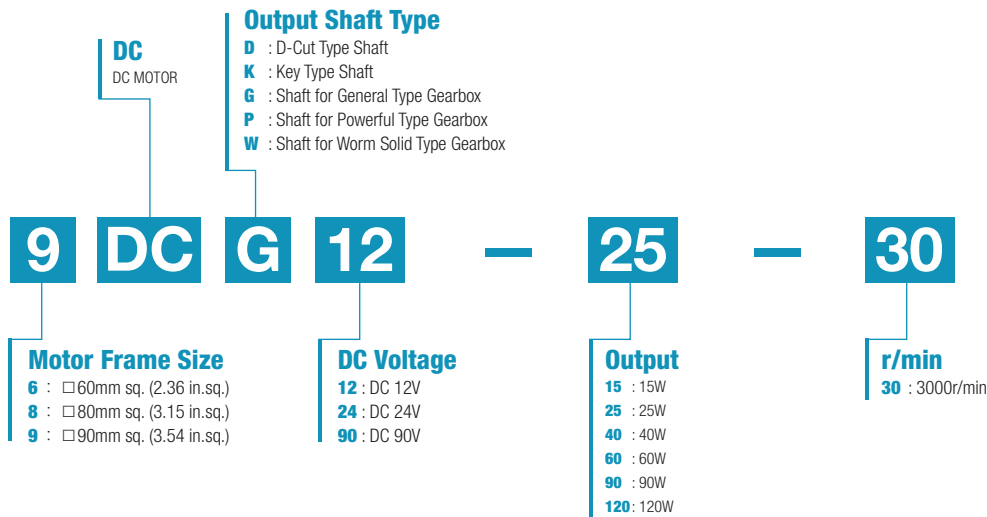

Parallel Gearbox

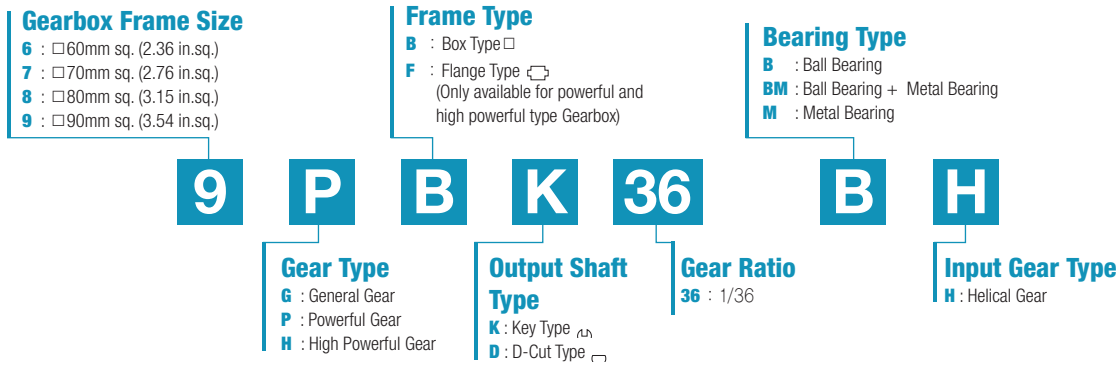

Worm Solid Gearbox

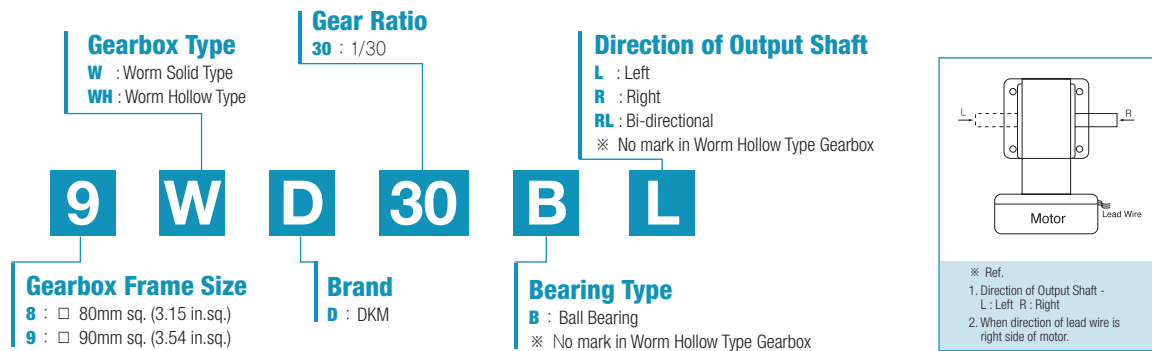

Worm Hollow Gearbox

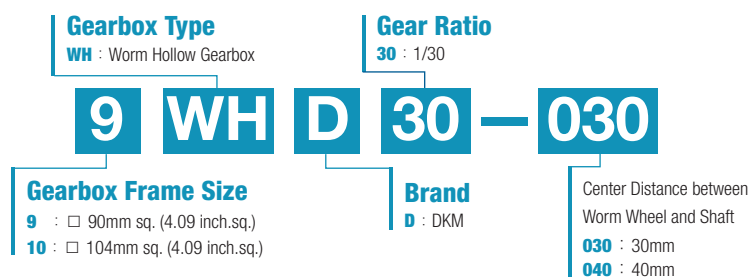

Inter-decimal Gearbox

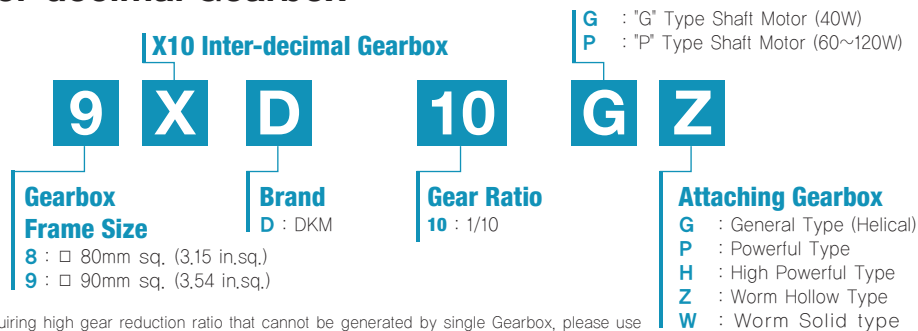

In case of requiring high gear reduction ratio that cannot be generated by single Gearbox, please use Inter-decimal Gearbox with general Gearbox. And please be advised that in this case only revolution speed of output shaft will reduce by 10:1 without increasing of maximum permissible torque.

A Information

Product Coding System

Assembly of Motor and Gearbox

Motor + Gearbox

- As shown in the following scheme, motor and Gearbox which have same frame size and gear type could be assembled.

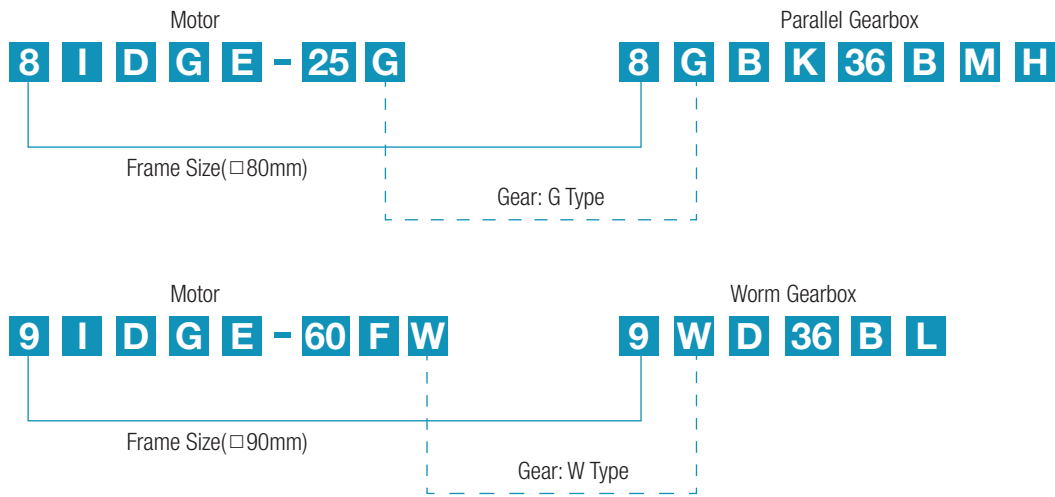

Motor + Inter-decimal Gearbox + Gearbox

- When using an inter-decimal Gearbox together, give attention to the gear types of motor, Gearbox and inter-decimal Gearbox.

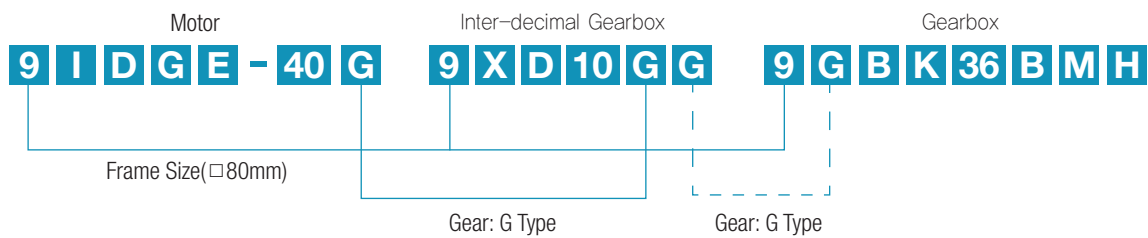

- When attaching inter-decimal Gearbox, the output shaft type of the motor is always G type. For example, when using P/H/W/WH type Gearbox, only the gear type of inter-decimal Gearbox is identical with attached Gearbox and the output shaft type of the motor is G type. (Refer to the scheme below.)

Induction Motor 250W(□ 104mm)

300W

Induction Motor
300W(□ 104mm)

Induction Motor 300W(□ 104mm)

Motor Specification

Model		Output W	Voltage V	Frequency Hz	Poles	Duty	Starting Torque		Rated Load			Capacitor μF / VAC	
Lead Wire Type	Terminal Box Type						kgfcm	N.m	Speed r/min	Current A	Torque kgfcm N.m		
-	10IDGD-300F□-T	300	1Ø 220	60	4	Cont.	13.60	1.360	1600	2.52	18.27	1.827	15.0 / 450
-	10IDG7-300F□-T	300	3Ø 230	50	4	Cont.	47.00	4.700	1300	1.70	22.48	2.248	-
			3Ø 400				47.00	4.700	1300	1.01	22.48	2.248	
-	10IDG8-300F□-T	300	3Ø 440	50	4	Cont.	47.00	4.700	1300	0.88	22.48	2.248	-
				60			35.00	3.500	1550	0.88	18.86	1.886	

- 1) Enter the phase & voltage code in the place * and enter the model type of attaching gearbox in the box (□) within the motor model name.
 - 2) voltage code E & D contain a built-in thermal protector.
 - 3) Gear Type Shaft is for attaching gearbox and D-Cut & Key Type Shafts are for using motor only.
- ※ It is not possible to use inverter for three phase 380~440V motor. When inverter is used, the insulation of winding coil becomes hot and may cause damage to the motor.

Max. Permissible Torque at Output Shaft of Gearbox

50Hz

Motor Model	Gearbox Model	Ratio	3	3.6	5	6	7.5	9	10	12.5	15	18	20	25	30	36	40	50	60	75	90	100	120	150	180
			r/min	600	500	360	300	240	200	180	144	120	100	90	72	60	50	45	36	30	24	20	18	15	12
10IDG7-300FU-T	10UBK	kgfcm	55	70	95	110	140	170	170	210	250	270	300	300	300	350	350	350	400	400	400	400	400	400	400
10IDG8-300FU-T	□BH	N.m	5.4	6.9	9.3	11	14	17	17	21	25	26	29	29	29	34	34	34	39	39	39	39	39	39	39

Motor Model	Gearbox Model	Gear Ratio	7.5	10	15	20	25	30	40	50	60	80	100
			r/min	200	150	100	75	60	50	37.5	30	25	18.75
10IDG7-300FWH-T	10WHD□-040	kgfcm	95	125	175	225	270	300	285	*	*	*	*
10IDG8-300FWH-T		N.m	9.30	12.20	17.10	22.00	26.40	29.40	27.90	*	*	*	*

60Hz

Motor Model	Gearbox Model	Ratio	3	3.6	5	6	7.5	9	10	12.5	15	18	20	25	30	36	40	50	60	75	90	100	120	150	180
			r/min	600	500	360	300	240	200	180	144	120	100	90	72	60	50	45	36	30	24	20	18	15	12
10IDGD-300FU-T	10UBK	kgfcm	45	55	75	90	115	135	140	170	205	225	250	300	300	350	350	350	400	400	400	400	400	400	400
10IDG8-300FU-T	□BH	N.m	4.41	5.39	7.35	8.82	11.27	13.23	13.72	16.66	20.09	22.05	24.5	29.4	29.4	34.3	34.3	34.3	39.2	39.2	39.2	39.2	39.2	39.2	39.2

Motor Model	Gearbox Model	Gear Ratio	7.5	10	15	20	25	30	40	50	60	80	100
			r/min	200	150	100	75	60	50	37.5	30	25	18.75
10IDGD-300FWH-T	10WHD□-040	kgfcm	115	150	215	275	335	375	350	*	*	*	*
10IDG8-300FWH-T		N.m	11.20	14.70	21.00	26.90	32.80	36.70	34.30	*	*	*	*

B AC Motors

Induction Motor 300W(□104mm)

Dimensions

MOTOR ONLY

MOTOR MODEL:
10IDK□-300F-T

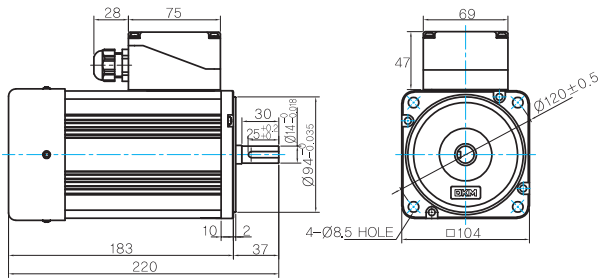

MOTOR OUTPUT SHAFT

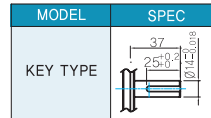

KEY SPEC

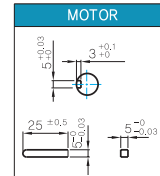

GEARED MOTOR

U TYPE GEARBOX

MOTOR MODEL:
10IDG□-300FU-T

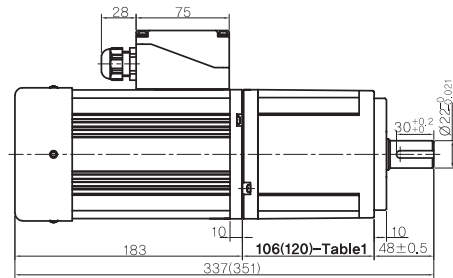

GEARBOX MODEL:
10UBK□BH-040

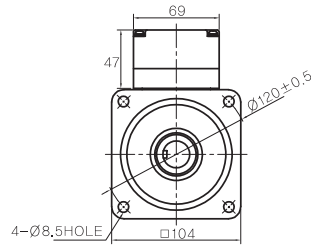

GEARBOX OUTPUT SHAFT

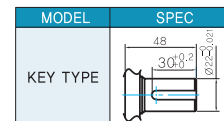

KEY SPEC

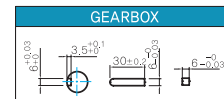

106(120)-Table1

SIZE(mm)	GEAR RATIO
106	10UBK3BH - 10UBK60BH
120	10UBK75BH - 10UBK180BH

WH TYPE GEARBOX

MOTOR MODEL:
10IDG□-300FWH-T

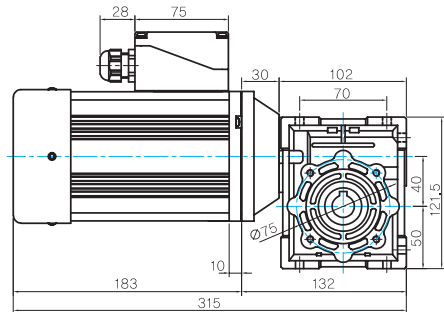

GEARBOX MODEL:
10WHD□-040

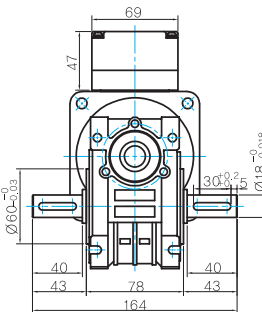

SHAFT

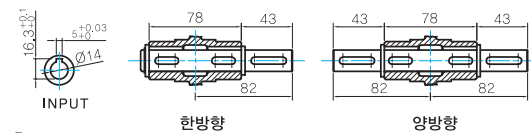

FLANGE

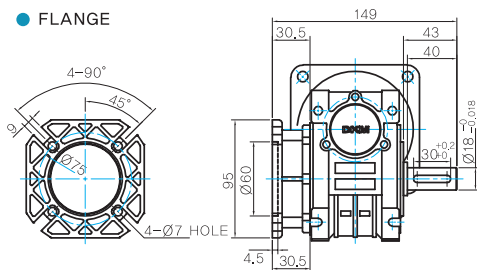

KEY SPEC

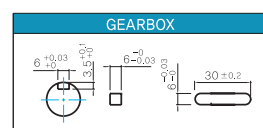

WEIGHT

PART	WEIGHT(kg)	
MOTOR	6.1	
GEAR BOX	10UBK3BH ~ 10UBK10BH	2.1
	10UBK12.5BH ~ 10UBK18BH	2.15
	10UBK20BH ~ 10UBK60BH	2.2
	10UBK75BH ~ 10UBK200BH	2.3
	10WHD□-040	2.2

* 출력 FLANGE와 SHAFT는 별매입니다.

Motor Images

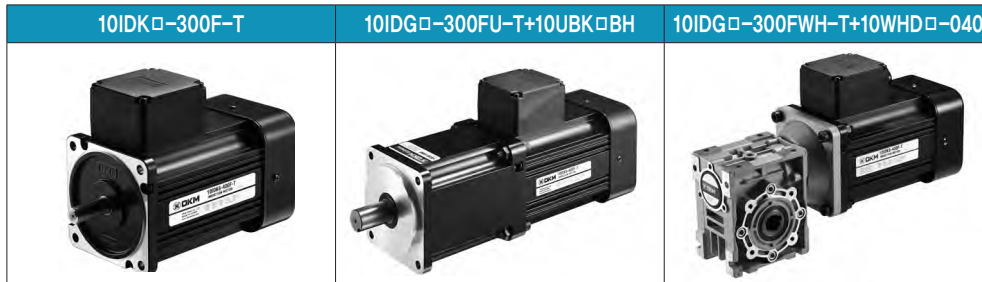

Connection Diagrams

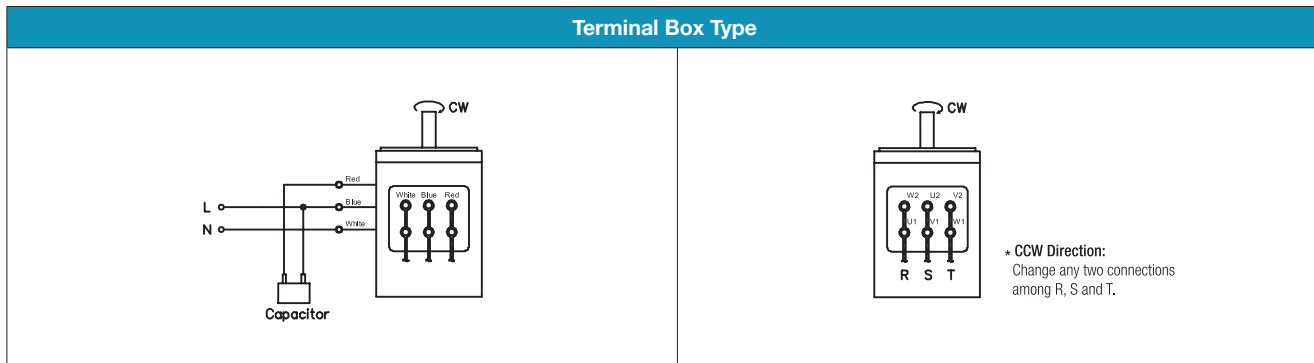

- 1) The direction of motor rotation is as viewed from the shaft end of the motor.
- 2) CW represents the clockwise direction, while CCW represents the counterclockwise direction.