

2 Pole Motor

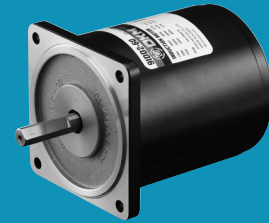

2 Pole Motor

Index

2 Pole Motor 15W (□ 80mm)	B-57
2 Pole Motor 25W (□ 80mm)	B-59
2 Pole Motor 40W (□ 90mm)	B-61
2 Pole Motor 60W (□ 90mm)	B-63
2 Pole Motor 90W (□ 90mm)	B-65
2 Pole Motor 120W (□ 90mm)	B-67
2 Pole Motor 150W (□ 90mm)	B-69
2 Pole Motor 200W (□ 90mm)	B-71

DKM AC/DC Geared Motor and Gearhead **B-56**

Änderungen und Irrtümer auch technischer Art vorbehalten!

B AC Motors

Technical Data of AC Motor

Definition of Motor

Motor is a machine to get a driving force for rotation or straight movement by converting the electrical energy into mechanical energy and the light-weighted motor which enables to select the model suitable for the load, has less noise and vibration as well as no exhaust pollution.

Features of DKM AC Motor

DKM AC geared motor was developed first in Korea in 1987 and has been used in a good reputation throughout the whole areas of domestic/overseas industry up to know. Our AC geared motor is proud of various and wide range of specification which satisfies various electrical requirements from all over the world.

Various and Abundant Models

- There are various and abundant models in frame size covering □ 60/70/80/90mm such as Induction Motor, 2 Pole Motor, Reversible Motor, E.M. Brake Motor, Clutch & Brake Motor, Torque Motor and Speed Control Motor.
- For use voltage, we have various voltage specification covering all areas in the globe: 100V 50/60Hz(Japan), 200V 50/60Hz(Japan), 110V 60Hz(Taiwan), 220V 60Hz(Korea, Taiwan), 115V 60Hz(North America), 230V 50Hz(Europe, Oceania), 220V/240V 50Hz(South-East Asia)

Low Noise and Low Vibration

- Due to the enhancement of quality standard such as places and conditions for motors to use, the low noise and low vibration are required.
- To satisfy these conditions, we employed high precision of gear processing and skiving cutting method and we are making a rotor which is the root cause of vibration by verifying with balance machine for low noise and low vibration.

Easy to Use

- Easy and safe to use as motor and Gearbox are sold according to the requirements so that it can be designed and manufactured optimally.
- It is easy to drive to get a driving force by connecting capacitor to the commercial power available to be used anywhere and anytime. As capacitor is not needed for three phase power, it is available to get a driving force easily by connecting three phase power to the motor directly.

Just-In-Time System

- Just-In-Time system is available in DKM Motor Co., Ltd. for the best delivery system. DKM realized user's satisfaction with the world best delivery system.

Types of Motor

Classification by Power

- **AC motor:** A motor operated by AC power. For example, inductive motor, synchronous motor, AC commutator motor etc.

1) Single Phase Motor

- Single phase power is composed of one phase as commercial power for home.
- As power itself does not make motor rotate, capacitor is connected to auxiliary coil to start.

2) Three Phase Motor

- Three phase motor stands for electrical power and it is consisted of three electrical sources with a phase offset of 120° in voltage.
- Connect the power to motor to start and the rotor will start to run easily.
- The efficiency of motor is high and the starting torque is relatively big.

- **DC motor:** A motor which rotates by supplying the direct current to the armature. The torque generated by placing the coil between magnetic poles N and S and applying the current to this coil rotates the motor. Whenever this coil passes the neutral shaft, it turns the direction of current reversely and rotates continuously

Classification by Function

● Motor with Constant Speed

1) Induction Motor: An induction motor is a type of AC motor where power is supplied to the rotor by means of electromagnetic induction. These motors are widely used in industrial drives, particularly polyphase induction motors, because they are rugged and have no brushes. Their speed is determined by the frequency of the supply current, so they are most widely used in constant-speed applications, although variable speed versions, using variable frequency drives are becoming more common.

2) Reversible Motor: A kind of induction motor and a motor having the same characteristic in any direction such as left turn or right turn. In principle, it is same as induction motor but there is no relation of main coil and auxiliary coil like general induction motor in order to stand frequent normal/reverse rotation and get a big starting torque.

● Brake Motor

It is a motor embedded with fail-safe electromagnetic brake. Perfect braking enables to get a staying power. Brake runs only when the power is shutdown, so this is suitable as a brake for safe use.

※ DKM has 'A Type' electronic brake motor which runs when the power is applied. (Customized specification)

● Clutch & Brake Motor

DKM Clutch & Brake motor is equipped with Clutch & Brake mechanism available to be used with Gearbox. As the continuously rotating induction motor and Clutch & Brake are combined, this can be used for frequent start/stop, position control, index operation and relative value feeding operation etc.

● Torque Motor

DKM torque motor has big starting torque and sloping characteristics. It runs safely over the whole area of rotation speed-torque characteristics. (Torque is highest at zero speed and decreases steadily with increasing speed.) With these characteristics, this can be used for more application as a winding or tension motor.

● Speed Control Motor

User can easily set and adjust the motor speed. There are three kinds of speed controller for AC speed motors. Select the best system depending upon your application.

Structure of AC Motor

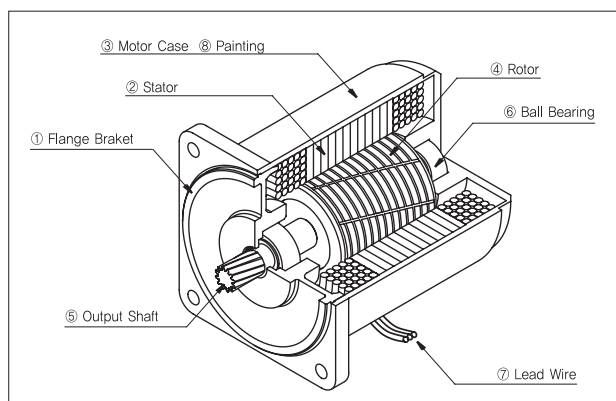

① Flange Bracket

Die-cast aluminum bracket is press-fitted into the motor case. The flange and the housing are a single body type which plays an important part to attach the motor alone or combine the Gearbox.

② Stator

This is comprised of a stator core made from laminated silicon/steel plates, a polyester-coated copper coil and insulation film. The roles are to generate magnetic field, form the rotation and run the rotor.

③ Motor Case

Die-cast aluminum with a machined finish inside

④ Rotor

It is comprised of laminated silicon/steel plates with die-cast aluminum. Rotor plays the part to change the electric energy to mechanical energy and transfer it to outside through shaft.

⑤ Output Shaft

There are D-cut type shaft, key type shaft which are for using by motor itself and gear type shaft (pinion shaft) which is for attaching Gearbox. It is made by S45C with a machined finish.

⑥ Ball Bearing

It ensures that the rotor remains at the right position for the reliability and fast rotational motion.

⑦ Lead Wire

Lead wires with heat-resistant polyethylene coating

⑧ Painting

Backed finish of acrylic resin and melamine resin with beautiful look

B AC Motors

Technical Data of AC Motor

Temperature Rise of AC Motor

Temperature Rise

- In operation of motor, the loss inside of motor is changed to heat causing the motor's temperature to rise.
 - Induction Motor (for continuous duty) reaches the saturation point of temperature rise in about two or three hours of operation and temperature stabilizes.
 - Reversible Motor (30 minutes rating) reaches their limit of temperature rise in about 30 minutes of operation. If operation continues as it is, the temperature will increase further.

Measuring Temperature Rise

- DKM uses the following methods for temperature measurement and for the determination of a motor's allowable temperature rise.
 - Thermometer Method: The temperature rise at which the temperature rise becomes saturated during motor operation is measured by using a thermometer or thermocouple installed in the center of the motor case. The temperature rise is the difference between the ambient temperature and measured temperature during motor operation.
 - Resistance Method: This is the way of measuring the winding temperature according to the change in resistance value. The motor's winding resistance and ambient temperature is measured by using a resistance meter and thermostat.

Overheating Protection Device

- In case of that a running motor locks due to overload or the input current increases due to any reason or ambient temperature increases suddenly, the motor's temperature rises abruptly. If this state continues, the insulation performance may deteriorate and, in extreme cases, it may cause a fire. To avoid this case, DKM employs the following overheating protection devices.
 - Thermal Protector (TP)**
DKM installs the thermal protector for overheating protection of the motor. The TP employs a bimetal contact with pure silver used in the contacts. Pure silver has the lowest electrical resistance of all materials and has thermal conductivity second only to copper.
(Operating Temperature: Open 120°C±5°C / Close 90°C±5°C)
 - Impedance Protection**
Impedance-protected motor has higher impedance in the motor windings so although the motor locks, the increase in input current is minimized and temperature will not rise.

Insulation Class

- DKM Motor's insulation class is B class. Insulation class is according to heat-resistance class. According to JIS C4003(IEC60085), it is defined as below. It is also available to use other materials for some particular insulation class according to operating conditions or user's request. (Customized specification)

Insulation Class	Max. Permissible Temp.
Y	90°C
A	105°C
E	120°C
B	130°C
F	155°C
H	180°C

FAN

- It is available to attach two kinds of fan to the DKM's motor; 'General Fan (F type)' and 'Powerful Fan (F2 type)'.
General fan is attached to motor shaft rotating in same speed as that of motor shaft. (1,800r/min in 60Hz, 1,500r/min in 50Hz) Powerful fan makes powerful cooling performance rotating in high speed regardless of motor shaft speed. (3,200r/min in 60Hz. Temperature reducing over 10°C is available comparing general fan.)
DKM employs general fan to the motors with continuous speed and employs powerful fan by customers' special order to the continuous speed's motor. But in case of speed control motor in which speed control is needed, powerful fan is employed basically because there is little cooling effect in low speed if general fan is used.

Equipment Protection Structure (IP Code)

- The IP code is one of the equipment protection structures and indicates the dust-resistance and waterproofing degrees of protection for the equipment.
- The code consists of the first number and the second number.



- "X" is used when one of the two protection classes is not specified in the name. (e.g. IPX5, IP4X)
- Meanings of IP code and testing conditions are as below;

1) The Classification of Dustproof

IP Code	Protection Specifications for Dustproof	
First Number	Protection Level	Test Condition
IP0□	None	None
IP1□	Protection against approach by hands	Solid objects with a diameter of 50mm or more do not enter.
IP2□	Protection against approach by fingers	Solid objects with a diameter of 12mm or more do not enter.
IP3□	Protection against tips of tools etc.	Solid objects with a diameter of 2.5mm or more do not enter.
IP4□	Protection against ingress of wires etc.	Solid objects with a diameter of 1.0mm or more do not enter.
IP5□	Protection against powdery dust	Powdery dust that may inhibit normal operation does not enter.
IP6□	Completely dustproof design	Cannot be penetrated by powdery dust.

2) The Classification of Waterproof

IP Code	Protection Specifications for Waterproof	
Second Number	Protection Level	Test Condition
IP□0	None	None
IP□1	Protection against water drops falling vertically	Water drops at a rate of 3 to 5L/min. for 10 minutes from a height of 200mm
IP□2	Protection against water drops from directions within a range of 15° relative to the vertical plane	Water drops at a rate of 3 to 5L/min. for 10 minutes from directions within 15° from a height of 200mm
IP□3	Protection against raindrops from directions within a range of 60° relative to the vertical plane	Sprayed water at a rate of 10L/min. for 10 minutes from directions within 60° from a height of 200mm
IP□4	Protection against ingress of splashes from all directions	Sprayed water at a rate of 10L/min. for 10 minutes from all directions at a distance of 300 to 500mm
IP□5	Protection against water jet from all directions	Sprayed water jet of 30kPa at a rate of 12.5L/min. for 3 minutes from all directions at a distance of 3m
IP□6	Protection against strong water jet such as ocean waves	Sprayed water jet of 100kPa at a rate of 100L/min. for 3 minutes from all directions at a distance of 3m
IP□7	Usable after immersion in water under specified conditions	Immersion to a depth of 1m for 30 minutes
IP□8	Usable under water	Determined through cooperation between user and manufacturer.

- The IP code of DKM's motor is indicated in the name plate (motor label).

Earth Method

Lead Wire Type

- As shown in the figure, connect the earth wire to the earth hole in the side of the motor.
Screw the earth wire to the earth hole. (Sequence: earth hole → washer → earth wire → screw bolt)

Terminal Box Type

- Connect the earth wire to the earth terminal in the terminal box.

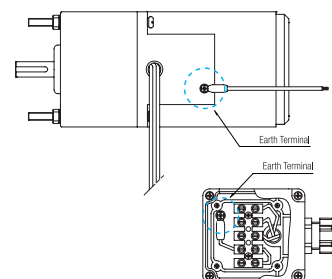

B AC Motors

Outline of Induction Motor

☐ Suitable for Unidirectional Continuous Operation

- Induction motors are suitable for unidirectional continuous operation such as conveyor belt system.

☐ Single Phase Run

- For the running of a single phase motor, please use the capacitor complying with the capacity of the motor. For a single phase induction motor, it is not possible to reverse the direction within a short time during operation. So stop the motor first and change the direction next. (Figure 1)

☐ Three Phase Run

- Three phase induction motor has relatively high starting torque comparing single phase motor and has high reliability because it can be directly operated by a three phase power source. (Figure 2)

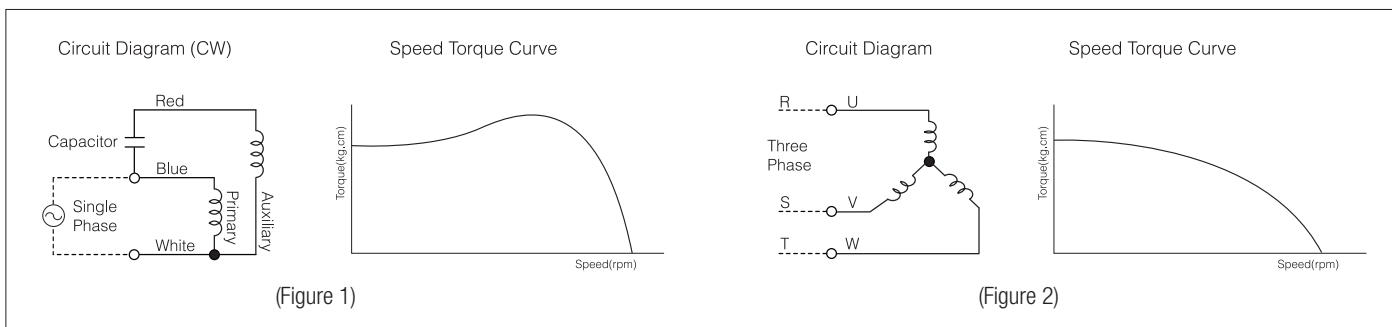

☐ The Relation between Speed and Torque

- In a condition of constant power voltage, the relation between speed and torque is like next figure. Under the condition of no-load, the number of rotation is roughly same as the number of synchronous rotation. But if the load increases, the number of rotation decreases and approaches to the speed (r/min) indicated by the point P where the torque T_p horizontally meets the load curve. When the load further increases and reaches the point M, the motor stops at the point R because the motor no longer generates further torque. Therefore, the leg R-M is referred to as an unstable zone and the leg O-M is a stable zone for operation.

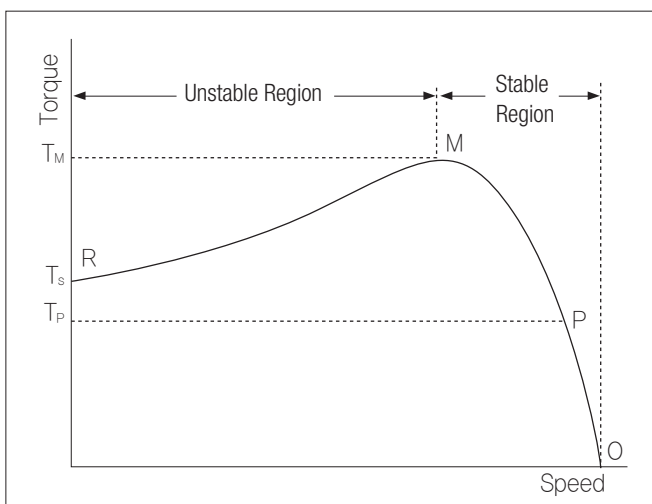

☐ Features of Voltage and Capacitor

- Generally the torque of induction motor changes proportionate to twice the voltage and it also changes according the capacity of the capacitor. If the capacity of the capacitor increases, the starting torque and rated torque will increase. But if the capacity increases by over 2 times, the rated torque decreases and starting torque do not increase. When the induction motor is short on torque, it is possible to increase the torque by increasing the voltage or the capacity of the capacitor to continue the operation. But please be informed that in this case the loss input of the motor increases and the temperature rises rapidly. However, if the motor must be run with insufficient torque, take measures to let the motor release heat as much as possible by installing separate fan as an example and operate the motor while keeping the temperature of the motor's housing below 90°C.

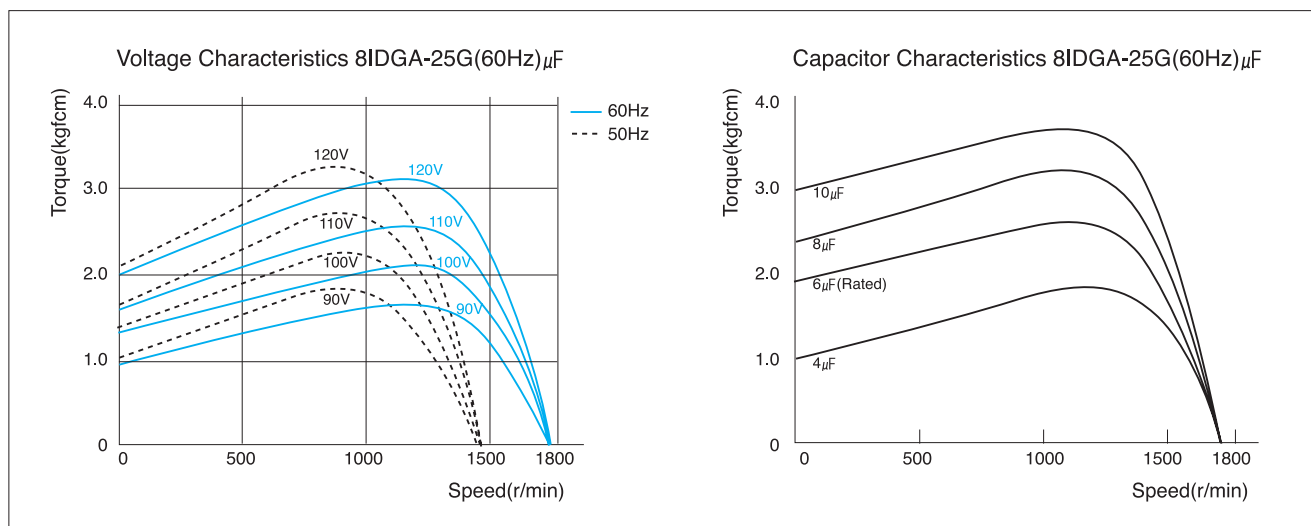

General Specifications

Item	Specification
Insulation Resistance	100MΩ or more when DC500V MEGA is applied between the windings and the frame after rated motor operation under normal ambient temperature and humidity.
Dielectric Strength	Sufficient to withstand 1.5KV at 50Hz and 60Hz applied between the windings and the frame for 1 minute after rated motor operation under normal ambient temperature and humidity.
Temperature Rise	Temperature rise of windings are 80°C or less measured by the resistance change method after rated motor operation with connecting a Gearbox or equivalent heat radiation plate.
Insulation Class	Class B [130°C]
Overheat Protection	Operating temperature (Built-in thermal protector type motor): Open 120°C±5°C, Close 90°C±5°C
Ambient Temperature	-10°C~+40°C (Three phase 220VAC: -10°C~+50°C)
Ambient Humidity	85% maximum

Connection Diagrams

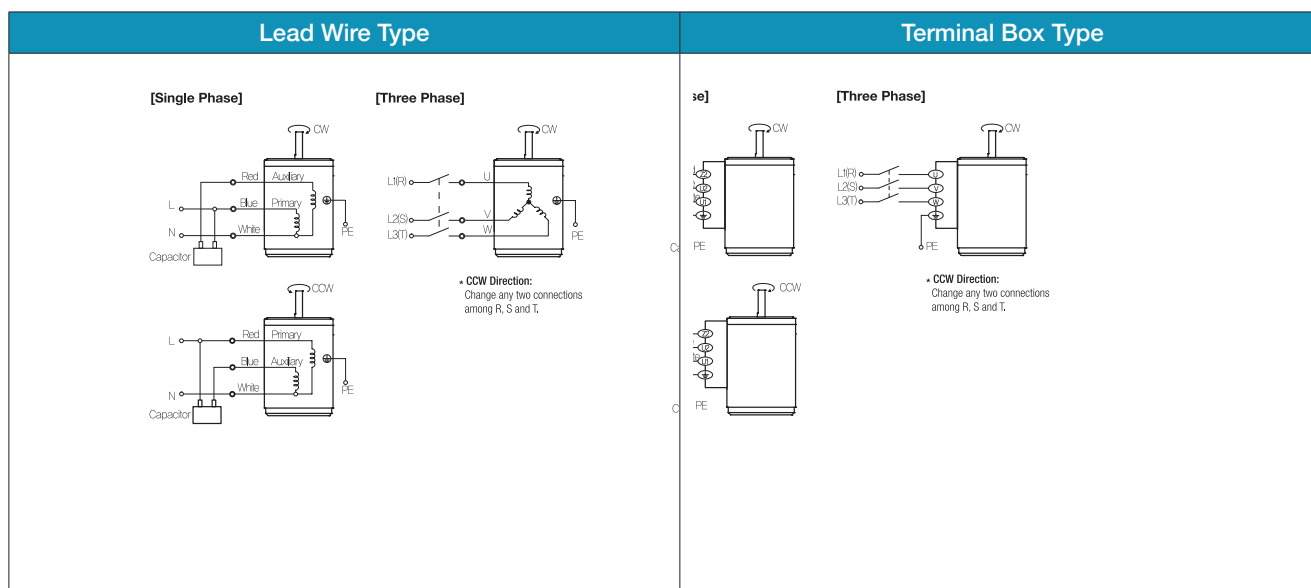

A Information

Product Coding System

AC Motors

Motor

- I** : Induction Motor
- R** : Reversible Motor
- B** : Electromagnetic Brake Motor
- Cl** : Clutch & Brake Motor
- T** : Torque Motor
- S** : Speed Control Induction Motor
- SR** : Speed Control Reversible Motor
- SB** : Speed Control . Brake Motor
- CS** : Speed Control Clutch & Brake Motor

9 I D G A

Motor Frame Size

- 6** : □60mm sq. (2.36 inch sq.)
- 7** : □70mm sq. (2.76 inch sq.)
- 8** : □80mm sq. (3.15 inch sq.)
- 9** : □90mm sq. (3.54 inch sq.)
- 10** : □104mm sq. (4.09 inch sq.)

Brand
D : DKM

Output Shaft Type

- G** : Gear Type Shaft
(Pinion Shaft for Attaching Gearbox)
- S** : Round Type Shaft ○
- D** : D-Cut Type Shaft □
- K** : Key Type Shaft ⊕

Phase & Voltage

- 1** : 1∅ AC 110V 60Hz
- 2** : 1∅ AC 220V 60Hz
- 3** : 3∅ AC 220~230V 50/60Hz
- 4** : 3∅ AC 380V~400V 50/60Hz
- 5** : 3∅ AC 415V~440V 50/60Hz
- 6** : 3∅ AC 220/380V 60Hz
- 7** : 3∅ AC 230/400V 50Hz
- 8** : 3∅ AC 440V 50/60Hz

Phase & Voltage

[Built-in Thermal Protector Type]

- A** : 1∅ AC 110V 60Hz
- D** : 1∅ AC 220V 60Hz
- E** : 1∅ AC 220~240V 50Hz
- G** : 3∅ AC 220V 50/60Hz
- K** : 3∅ AC 380V~400V 50/60Hz
- L** : 3∅ AC 415V~440V 50/60Hz

Fan Type

- F** : General Fan (Self Cooling)
- F2** : Powerful Fan (Separate Fan Motor)
Powerful fan makes powerful cooling performance rotating in high speed regardless of motor shaft speed.
- No Mark** : Without Fan

Connection Type

- T** : Terminal Box Type
- No Mark** : Lead Wire Type

Pole

- A** : 2 Pole
- No Mark** : 4 Pole

90 F P - A T

Output

- 6** : 6W
- 10** : 10W
- 15** : 15W
- 25** : 25W
- 40** : 40W
- 60** : 60W
- 90** : 90W
- 120** : 120W
- 150** : 150W
- 180** : 180W
- 200** : 200W
- 250** : 250W (E)
- 300** : 300W (D, 7, 8)
- 400** : 400W (6)

Attaching Gearbox

- G** : General Box Type
- P** : Powerful Box/Flange Type
- H** : High Powerful Box/Flange Type
- W** : Worm Solid Type
- WH** : Worm Hollow Type
- No Mark** : Without Gearbox

DC Motors

DC
DC MOTOR

Output Shaft Type

- D** : D-Cut Type Shaft
- K** : Key Type Shaft
- G** : Shaft for General Type Gearbox
- P** : Shaft for Powerful Type Gearbox
- W** : Shaft for Worm Solid Type Gearbox

9 DC G 12 - 25 - 30

Motor Frame Size

- 6** : □60mm sq. (2.36 in.sq.)
- 8** : □80mm sq. (3.15 in.sq.)
- 9** : □90mm sq. (3.54 in.sq.)

DC Voltage

- 12** : DC 12V
- 24** : DC 24V
- 90** : DC 90V

Output

- 15** : 15W
- 25** : 25W
- 40** : 40W
- 60** : 60W
- 90** : 90W
- 120** : 120W

r/min

- 30** : 3000r/min

Parallel Gearbox

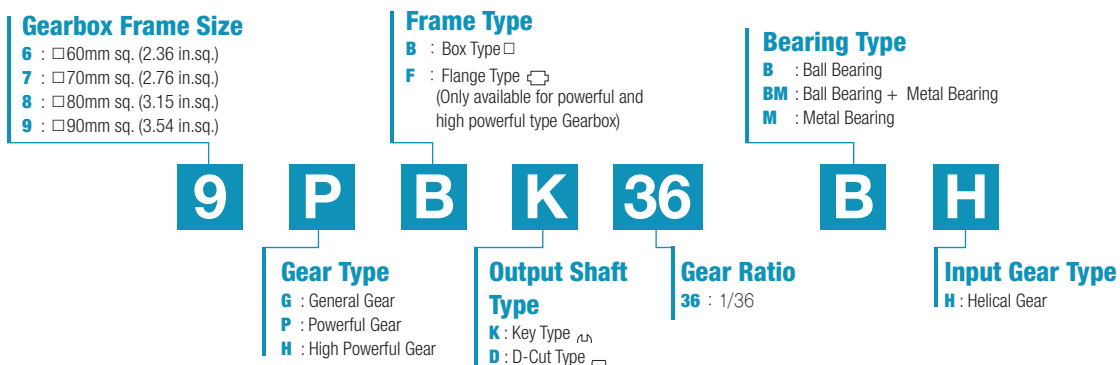

Worm Solid Gearbox

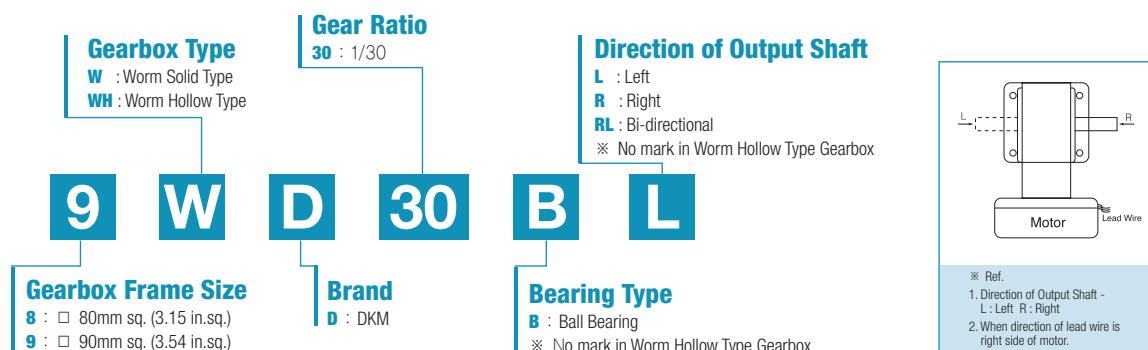

Worm Hollow Gearbox

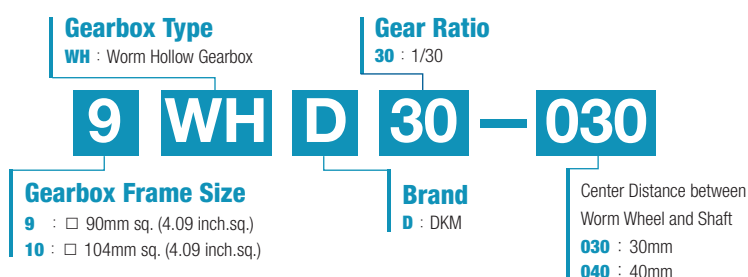

Inter-decimal Gearbox

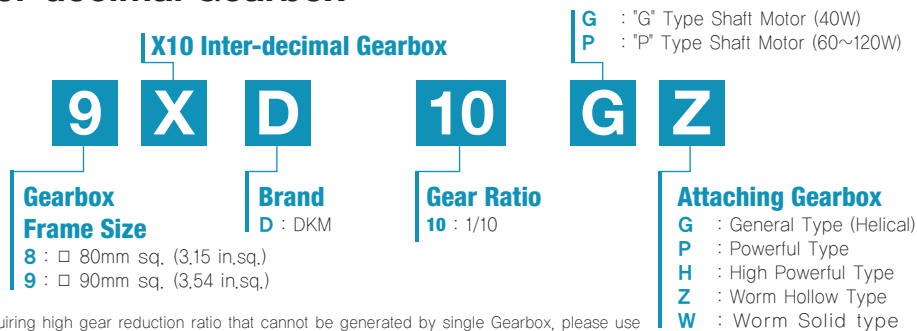

In case of requiring high gear reduction ratio that cannot be generated by single Gearbox, please use Inter-decimal Gearbox with general Gearbox. And please be advised that in this case only revolution speed of output shaft will reduce by 10:1 without increasing of maximum permissible torque.

A Information

Product Coding System

Assembly of Motor and Gearbox

Motor + Gearbox

- As shown in the following scheme, motor and Gearbox which have same frame size and gear type could be assembled.

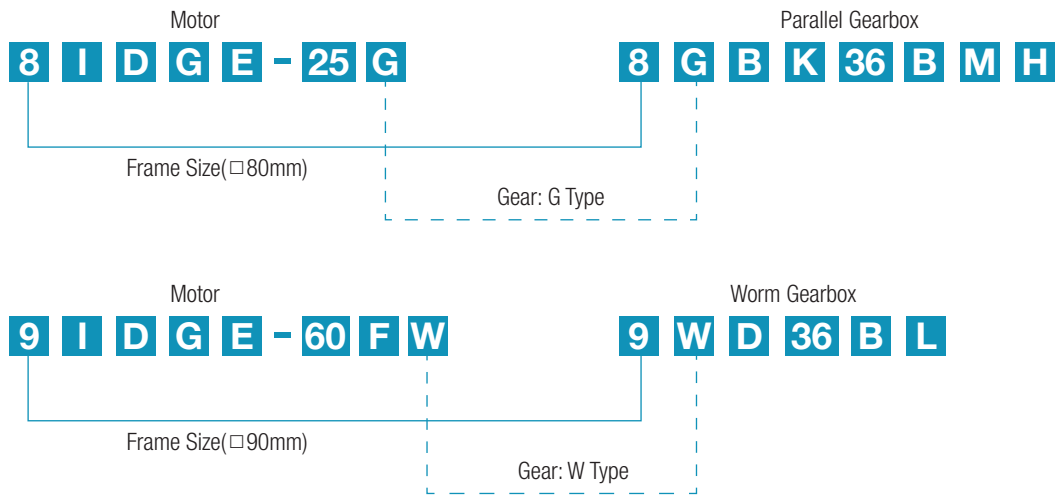

Motor + Inter-decimal Gearbox + Gearbox

- When using an inter-decimal Gearbox together, give attention to the gear types of motor, Gearbox and inter-decimal Gearbox.

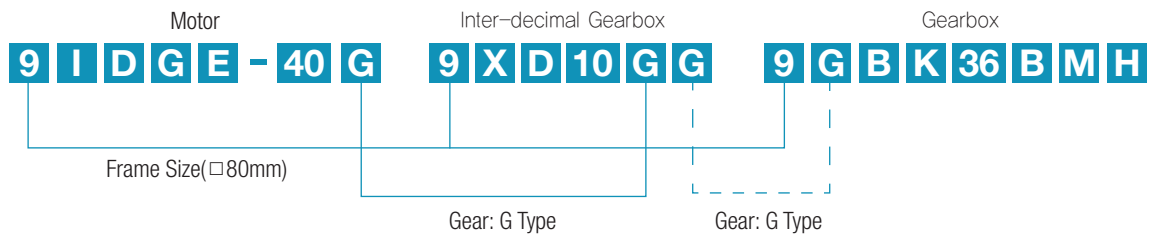

- When attaching inter-decimal Gearbox, the output shaft type of the motor is always G type. For example, when using P/H/W/WH type Gearbox, only the gear type of inter-decimal Gearbox is identical with attached Gearbox and the output shaft type of the motor is G type. (Refer to the scheme below.)

B AC Motors

2 Pole Motor 120W(□90mm)

120W

2 Pole Motor
120W(□90mm)

Motor Specification

Model		Output	Voltage	Frequency	Poles	Duty	Starting Torque		Rated Load			Capacitor	
9IDD□-120F-A(T): D-Cut Type Shaft 9IDK□-120F-A(T): Key Type Shaft									W	V	Hz		Speed
Lead Wire Type	Terminal Box Type						kgfcm	N.m	r/min	A	kgfcm	N.m	μF / VAC
9IDDA-120F-A	9IDDA-120F-AT	120	1∅110	60	2	Cont.	3.00	0.300	3100	2.40	3.80	0.380	25.0 / 250
9IDDD-120F-A	9IDDD-120F-AT	120	1∅220	60	2	Cont.	3.00	0.300	3100	1.40	3.80	0.380	6.5 / 450
9IDDE-120F-A	9IDDE-120F-AT	120	1∅220	50	2	Cont.	3.20	0.320	2500	1.20	4.70	0.470	6.5 / 450
			1∅240				3.80	0.380		1.40	5.20	0.520	
9IDDG-120F-A	9IDDG-120F-AT	120	3∅220	50	2	Cont.	12.00	1.200	2650	0.82	4.45	0.445	-
				60			10.00	1.000	3250	0.60	3.60	0.360	
9IDDK-120F-A	9IDDK-120F-AT	120	3∅380	50	2	Cont.	12.00	1.200	2650	0.46	4.60	0.460	-
				60			10.00	1.000	3200	0.35	3.65	0.365	
			3∅400	50	2	Cont.	13.00	1.300	2700	0.53	4.40	0.440	
				60			11.00	1.100	3200	0.38	3.85	0.385	
			3∅415	50	2	Cont.	14.00	1.400	2700	0.60	4.60	0.460	
				60			12.00	1.200	3250	0.41	3.65	0.365	
			3∅440	50	2	Cont.	16.00	1.600	2750	0.68	4.30	0.430	
				60			14.00	1.400	3250	0.45	3.80	0.380	

1) Enter the phase & voltage code in the box (□) within the motor model name.

2) All models contain a built-in thermal protector.

* It is not possible to use inverter for three phase 380~440V motor. When inverter is used, the insulation of winding coil becomes hot and may cause damage to the motor.

Dimensions

LEAD WIRE TYPE

MOTOR MODEL: 9IDD□-120F-A (GENERAL FAN)

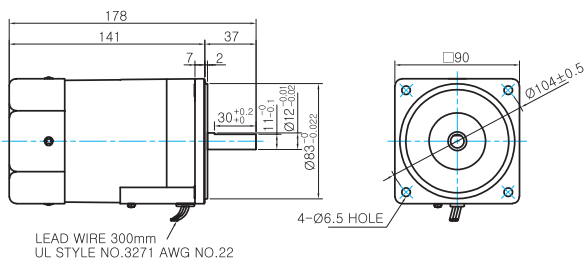

MOTOR OUTPUT SHAFT

MODEL	SPEC
D-CUT TYPE	
KEY TYPE	

KEY SPEC

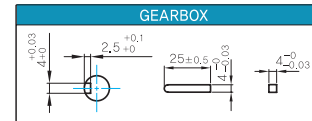

TERMINAL BOX TYPE

MOTOR MODEL: 9IDD□-120F-AT (GENERAL FAN)

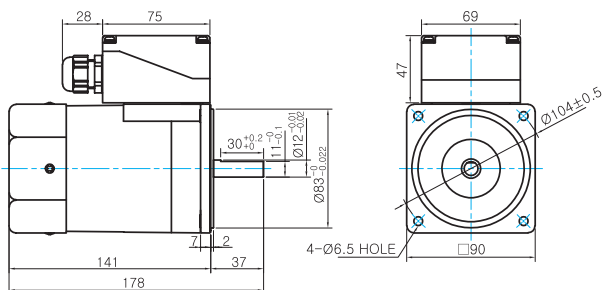

WEIGHT

PART	WEIGHT(Kg)
MOTOR	3,0

Motor Images

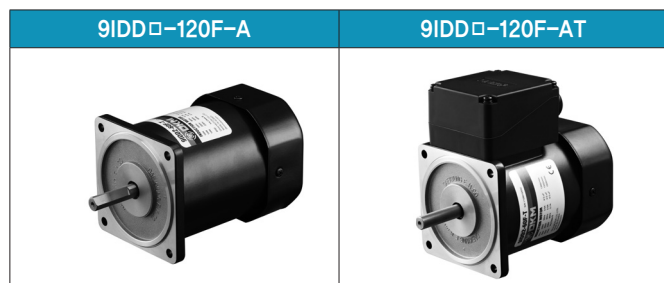

Connection Diagrams

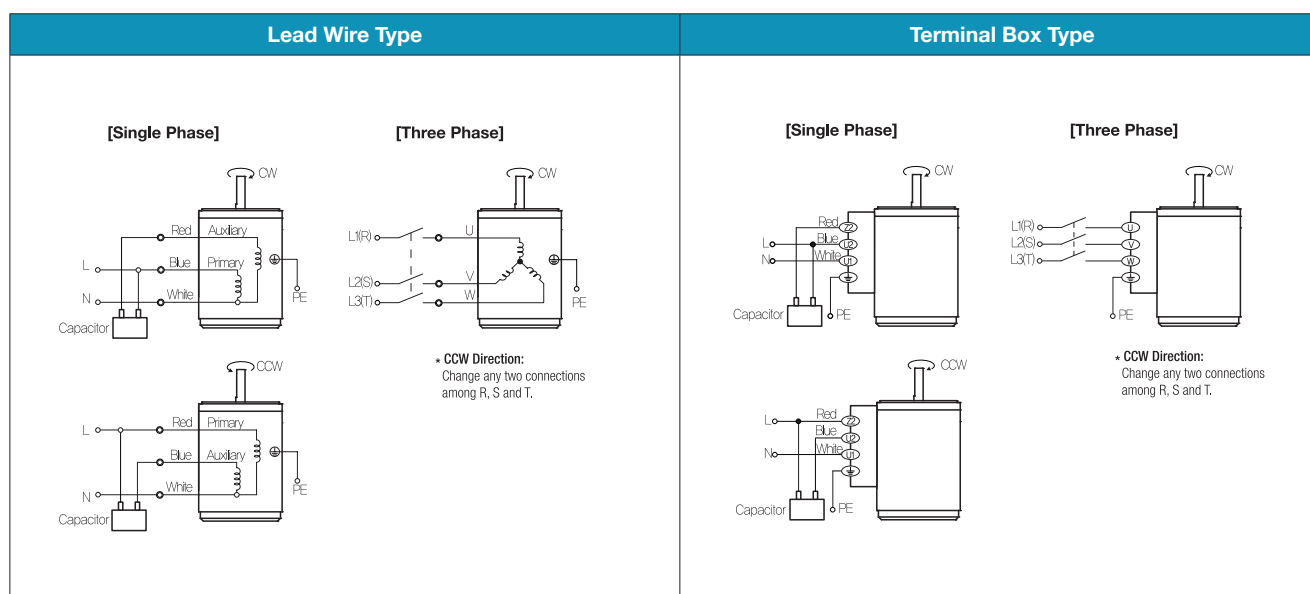

- 1) The direction of motor rotation is as viewed from the shaft end of the motor.
- 2) CW represents the clockwise direction, while CCW represents the counterclockwise direction.
- 3) Change the direction of single phase motor rotation only after bringing the motor to a stop. If an attempt is made to change the direction of rotation while the motor is rotating, the motor may ignore the reversing command or change its direction after some delay.