

**DC  
Motors**

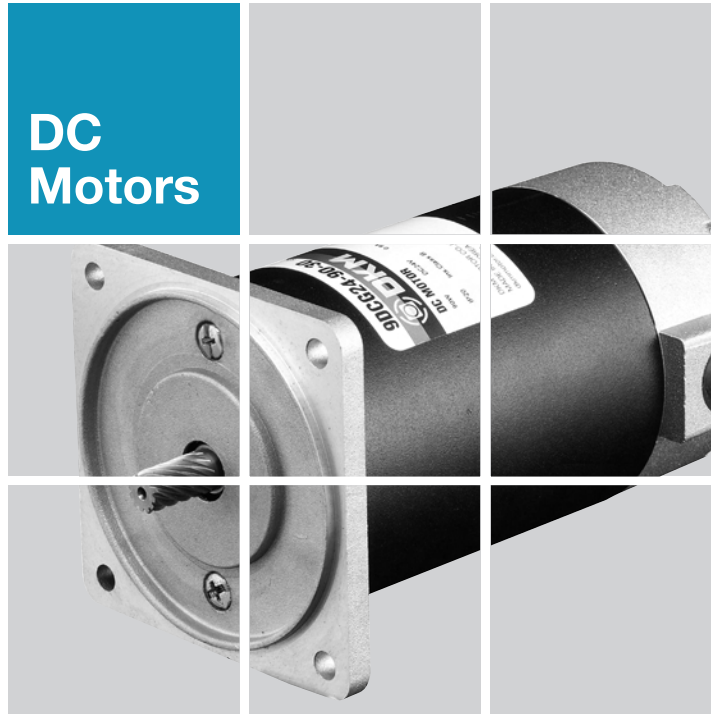

## Contents ▶▶

### **A** Information

- A-01 Product Coding System
- A-04 Products Lineup
- A-08 General Information
- A-12 Terminology
- A-15 Caution for Using

### **B** AC Motors

- B-01 Technical Data of AC Motor
- B-06 Induction Motor
- B-56 2 Pole Motor
- B-74 Reversible Motor
- B-106 Brake Motor
- B-148 Clutch & Brake Motor
- B-162 Torque Motor
- B-176 Speed Control System
  - B-179 Speed Controller FX1000A
  - B-181 Speed Controller DSKM
  - B-186 Speed Control Induction Motor
  - B-222 Speed Control Reversible Motor
  - B-250 Speed Control Brake Motor
  - B-276 Speed Control Clutch & Brake Motor

### **C** DC Motors

- C-01 Technical Data of DC Motor
- C-04 DC Motor
- C-17 Speed Controller DSD-90

### **D** Gearboxes

- D-01 Technical Data of Gearbox
- D-07 Parallel Gearbox
- D-13 Worm Gearbox
- D-16 Inter-decimal Gearbox

### **E** Options

- E-01 Mounting Plate
- E-02 Extension Cable
- E-03 Output Flange / Output Shaft

# C DC Motors

## Technical Data of DC Motor

### Features

- DC motor has a big starting torque and excellent mobility and when comparing with the same sized AC motor, the output is big and the efficiency is high.
- It is easy to control the speed and change the normal/reverse rotation.
- Comparing to AC motor, it is available to manufacture low voltage motor which can be applied to portable machine which uses various spec., especially battery power (12V, 24V).
- Due to the wear of brush, there is a limit in the service life.
- Due to brush and commutator, noise generates when starting.

### Current, Torque and Speed (r/min)

When the voltage of power supply is fixed, D.C. magnet motor shows the characteristic in the relationship between torque, speed and current as below. The relationship is almost linear show as the above, and the speed decreases, and current increases conversely when increasing the torque to the output shaft motor. It is same until the output shaft of motor is done a stall, when ignored heat generation in the motor. (It is possible to control the torque by controlling the current.)

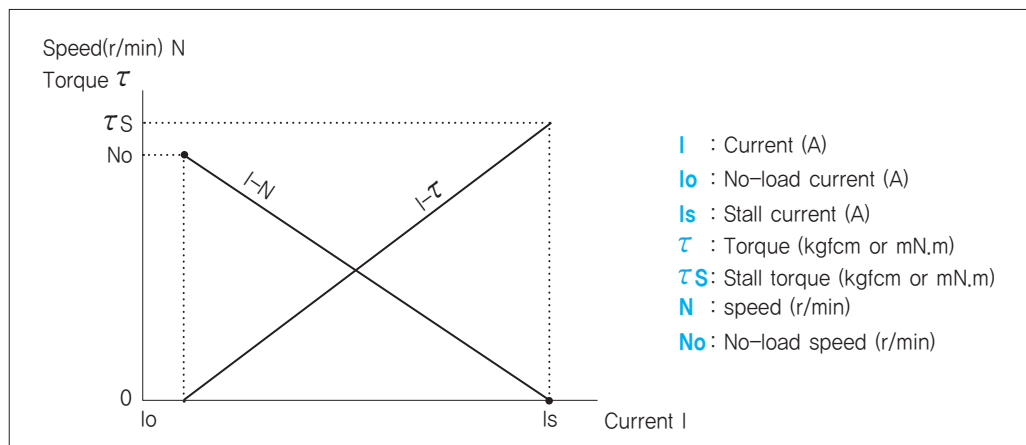

### Rating Time

According to increase of current (torque), heat generation in the motor increases. Generally, when the temperature of component parts in the motor is below than allowable temperature after it was saturated, it is possible to keep continuous operation.

When it was not saturated in the allowable temperature, the time to exceed the temperature is rating time of motor and it is short-time rating specification. According to size and the specification, each motor model has different current (torque) value to be possible continuous operation.

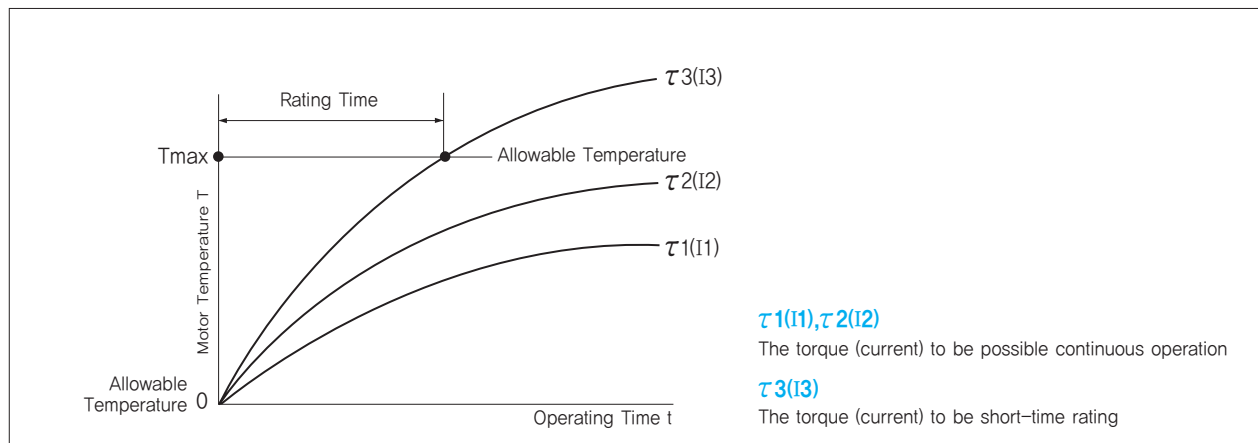

## Performance of DC Motor in Case of Voltage Change at Power Supply

DC magnet motor can change speed by changing power supply voltage. The relationship between torque( $\tau$ ), speed(N) and current(I) of motor when the voltage is half (1/2) is shown as below.

As the below figure, in the relationship between current and speed when power supply voltage was changed to half (1/2), ideal no-load speed "Nt" becomes "Nt/2" and it falls parallel to the performance of rated voltage.

The relationship between current and torque is same as the rated voltage, but the stall current " $\tau_s$ " falls accordingly as the stall current "Is" becomes "Is/2".

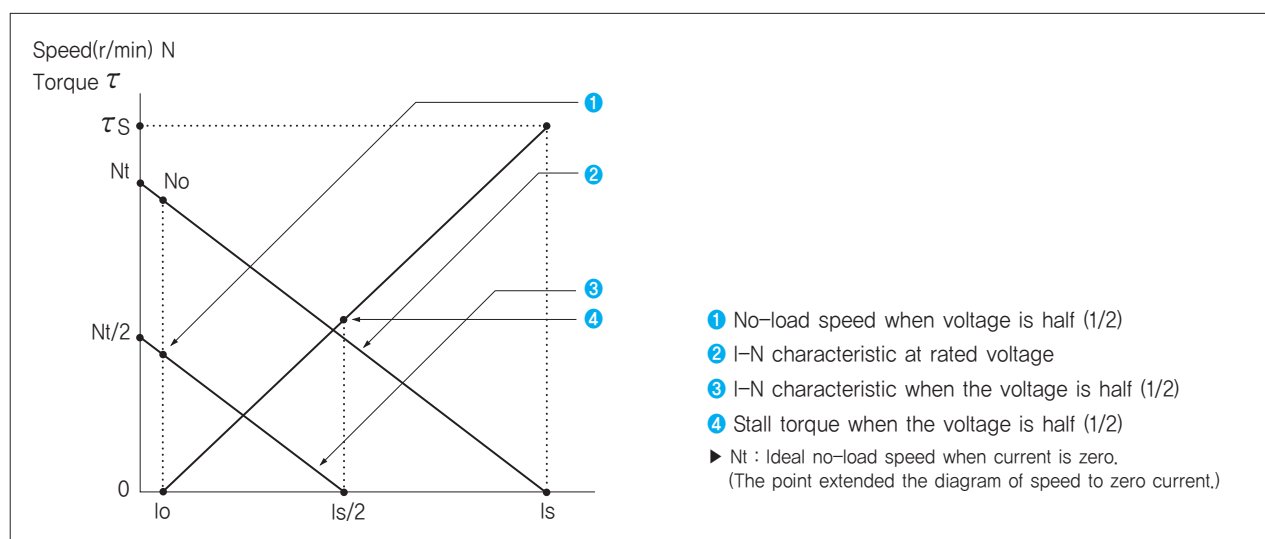

## Input, Output and Efficiency of DC motor

The input, output and efficiency can be calculated with the next formula.

**Input(W)** = Power Supply Voltage (V) X Current (A)

**Output(W)** = Torque  $\tau$  (kgfcm) X Speed N (r/min) X  $1.027 \times 10^{-2}$

**Efficiency  $\eta$  (%)** =  $\frac{\text{Output(W)}}{\text{Input(W)}} \times 100$

## General Specifications

Item	Specification
Insulation Resistance	100M $\Omega$ or more when DC500V MEGA is applied between the windings and the frame after rated motor operation under normal ambient temperature and humidity.
Dielectric Strength	Sufficient to withstand 1.5KV at 50Hz and 60Hz applied between the windings and the frame for 1 minute after rated motor operation under normal ambient temperature and humidity.
Temperature Rise	Temperature rise of windings are 80°C or less measured by the resistance change method after rated motor operation with connecting a Gearbox or equivalent heat radiation plate.
Insulation Class	Class B [130°C]
Ambient Temperature	-10°C~+40°C
Ambient Humidity	85% maximum

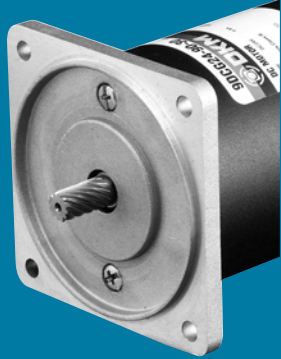

# DC Motor



DC Motor

## Index

DC Motor 90W (□90mm)

C-13

DKM AC/DC Geared Motor and Gearbox **C-04**

# C DC Motors

DC Motor 90W(□90mm)

## 90W DC Motor 90W(□90mm)

### Motor Specification

Model 9DCP(W)□-90-30: Gear Type Shaft 9DCD□-90-30: D-Cut Type Shaft 9DCK□-90-30: Key Type Shaft	Output W	Voltage V	Starting Current A	Starting Torque		No Load		Rated Load			
				kgfcm	N.m	Current A	Speed r/min	Current A	Speed r/min	Torque kgfcm N.m	
9DCP(W)12-90-30	90	12	80.00	21.00	2.100	3.00	3400	12.00	3000	2.92	0.292
9DCP(W)24-90-30	90	24	55.00	29.00	2.900	1.50	3400	6.20	3000	2.92	0.292
9DCP(W)90-90-30	90	90	15.00	31.00	3.100	0.12	3300	1.20	3000	2.92	0.292

- 1) Enter the phase & voltage code in the in the box (□) within the motor model name.  
2) Gear Type Shaft are for attaching Gearbox and D-Cut & Key Type Shafts are for using motor only.

### Performance Curve

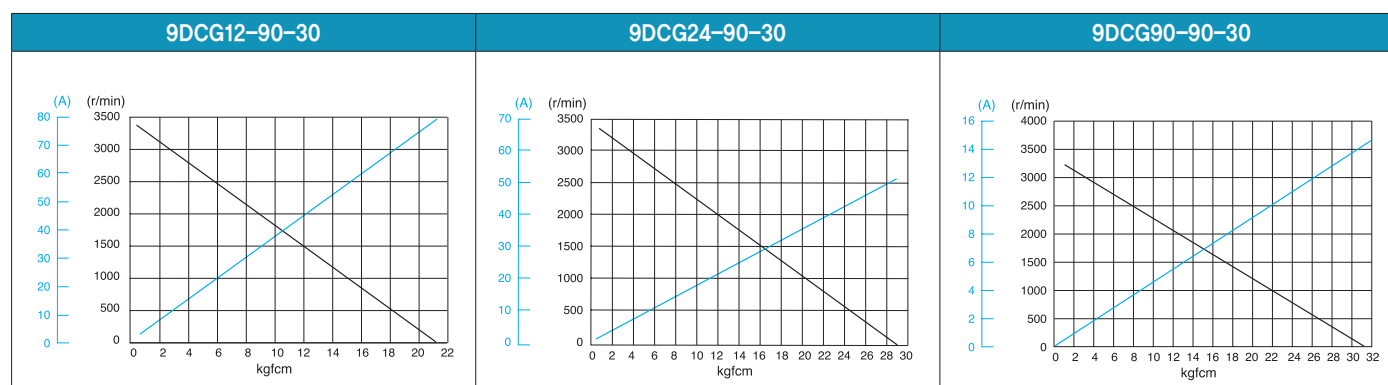

### Max. Permissible Torque at Output Shaft of Gearbox

Motor Model	Gearbox Model	Gear Ratio r/min	Gear Ratio																								
			2	3	3.6	5	6	7.5	9	12.5	15	18	20	25	30	36	40	50	60	75	90	100	120	150	180	200	
9DCP □-90- 30	9PBK □ BH	Rated	kgfcm	4.8	7.3	8.7	12.1	14.5	18.2	21.8	27.4	32.9	39.4	39.7	49.6	59.6	71.5	79.4	99.3	119.1	133.6	160.3	178.1	200.0	200.0	200.0	200.0
		N.m	0.48	0.71	0.86	1.19	1.43	1.78	2.14	2.68	3.22	3.86	3.89	4.86	5.84	7.01	7.78	9.73	11.68	13.09	15.71	17.46	19.60	19.60	19.60	19.60	
	9PFK □ BH	12V	kgfcm	34.9	52.3	62.7	87.2	104.6	130.7	156.9	200.0	200.0	200.0	200.0	200.0	200.0	200.0	200.0	200.0	200.0	200.0	200.0	200.0	200.0	200.0	200.0	200.0
		N.m	3.42	5.12	6.15	8.54	10.25	12.81	15.37	19.60	19.60	19.60	19.60	19.60	19.60	19.60	19.60	19.60	19.60	19.60	19.60	19.60	19.60	19.60	19.60	19.60	
	90V	24V	kgfcm	48.1	72.2	86.7	120.4	144.4	180.5	200.0	200.0	200.0	200.0	200.0	200.0	200.0	200.0	200.0	200.0	200.0	200.0	200.0	200.0	200.0	200.0	200.0	200.0
		N.m	4.72	7.08	8.49	11.79	14.15	17.69	19.60	19.60	19.60	19.60	19.60	19.60	19.60	19.60	19.60	19.60	19.60	19.60	19.60	19.60	19.60	19.60	19.60	19.60	
		Starting	kgfcm	51.5	77.2	92.6	128.7	154.4	193.0	200.0	200.0	200.0	200.0	200.0	200.0	200.0	200.0	200.0	200.0	200.0	200.0	200.0	200.0	200.0	200.0	200.0	
		N.m	5.04	7.56	9.08	12.61	15.13	18.91	19.60	19.60	19.60	19.60	19.60	19.60	19.60	19.60	19.60	19.60	19.60	19.60	19.60	19.60	19.60	19.60	19.60		

Motor Model	Gearbox Model	Gear Ratio		Gear Ratio									
		r/min	r/min	10	12	15	18	25	30	36	50	60	
9DCW □-90-30	9WD □BL/□BR/ □BRL	Rated	kgfcm	23.9	28.0	33.7	38.9	51.1	57.8	67.3	87.6	96.4	
			N.m	2.35	2.75	3.31	3.81	5.01	5.67	6.59	8.58	9.44	
		12V	Starting	kgfcm	163.3	153.1	163.3	153.1	142.9	163.3	153.1	142.9	122.4
			N.m	16.00	15.00	16.00	15.00	14.00	16.00	15.00	14.00	12.00	
		24V	Starting	kgfcm	163.3	153.1	163.3	153.1	142.9	163.3	153.1	142.9	122.4
			N.m	16.00	15.00	16.00	15.00	14.00	16.00	15.00	14.00	12.00	
90V	Starting	kgfcm	163.3	153.1	163.3	153.1	142.9	163.3	153.1	142.9	122.4		
	N.m	16.00	15.00	16.00	15.00	14.00	16.00	15.00	14.00	12.00			

- 1) Enter the phase & voltage code in the box (□) within the motor model name.  
2) Enter the gear ratio in the box (□) within the Gearbox model name.  
3) A colored background indicates gear shaft rotation in the same direction as the motor shaft; a white background indicates rotation in the opposite direction.  
4) The rotating speed is calculated by dividing the motor's synchronous speed (50Hz: 1,500r/min, 60Hz: 1,800r/min) by the gear ratio.  
The actual speed is 2~20% less than the displayed value, depending on the size of the load.

## Dimensions

### MOTOR ONLY

- MOTOR MODEL: 9DCD□-90-30

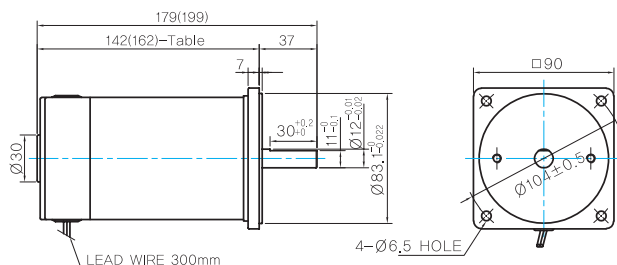

### MOTOR OUTPUT SHAFT

MODEL	SPEC
D-CUT TYPE	36.5 30 <sup>+0.2</sup> <sub>-0.1</sub> 11 <sup>+0.1</sup> Ø12 <sup>+0.01</sup>
9DCD□-90-30	36.5 25 <sup>+0.2</sup> <sub>-0.1</sub> Ø12 <sup>+0.01</sup>
KEY TYPE	36.5 25 <sup>+0.2</sup> <sub>-0.1</sub> Ø12 <sup>+0.01</sup>
9DCK□-90-30	36.5 25 <sup>+0.2</sup> <sub>-0.1</sub> Ø12 <sup>+0.01</sup>

### KEY SPEC

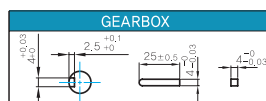

### INTER-DECIMAL GEARBOX

- MODEL: 9XD10□□

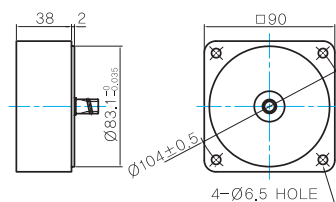

### 142(162)-Tablet

SIZE(mm)	MOTOR VOLTAGE
142	24V,90V
162	12V

## GEARED MOTOR

### P TYPE GEARBOX

- MOTOR MODEL: 9DCP□-90-30

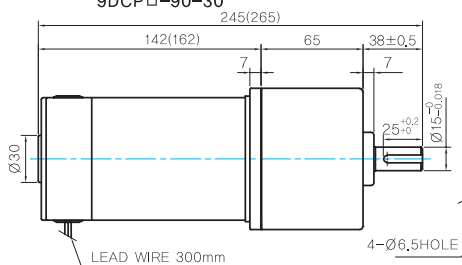

- GEARBOX MODEL: 9PBK□BH

- GEARBOX MODEL: 9PFK□BH

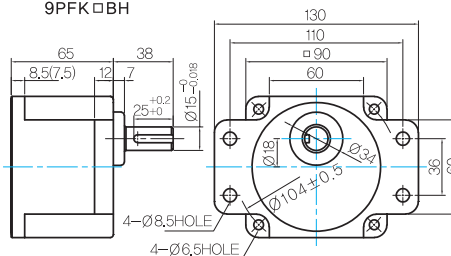

### GEARBOX OUTPUT SHAFT

MODEL	SPEC
KEY TYPE	38 25 <sup>+0.2</sup> <sub>-0.1</sub> Ø12 <sup>+0.01</sup>
9PBK□BH	38 25 <sup>+0.2</sup> <sub>-0.1</sub> Ø12 <sup>+0.01</sup>
9PFK□BH	38 25 <sup>+0.2</sup> <sub>-0.1</sub> Ø12 <sup>+0.01</sup>

### KEY SPEC

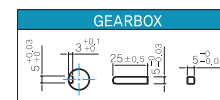

### W TYPE GEARBOX

- MOTOR MODEL: 9DCW□-90-30

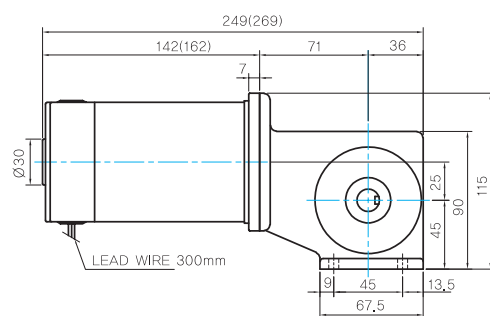

- GEARBOX MODEL: 9WD□BL/BR/BRL

### KEY SPEC

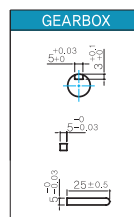

### WEIGHT

PART	WEIGHT(Kg)	
MOTOR	2,0	
GEAR BOX	9PB(F)K2BH ~ 9PB(F)K18BH	1,3
	9PB(F)K20BH ~ 9PB(F)K180BH	1,4
	9WD□BL/BR/BRL	1,0
9XD10□□	0,5	

## Motor Images

